

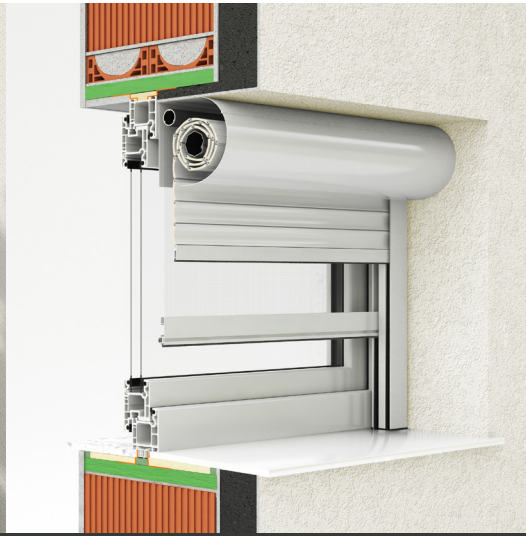

External roller shutter OVAL



- HEAT PROTECTION
- ANTI-THEFT PROTECTION
- LIGHT REGULATION
- DIMMING
- UV PROTECTION
- HEATING / COOLING SAVINGS

One of the most sophisticated mount-on visible shutters is definitely the OVAL shutter because its shape additionally contributes to a better exterior appearance. The oval box forms a completed whole with the shutters and the facade. The oval box is composed of three parts: rear, top, and front service panel, all of which are made of extruded aluminium, which adds the extra stiffness and a better appearance to the box.

SLATS | Color palette:

| | | | | | |
|--|-----|------------------|---------------|-----------|-------------|
| | PC1 | 01 WHITE | 02 D. CHOCO | 03 SILVER | 04 BEIGE |
| | | 11 ANTIKO GRIGIO | 12 ANTHRACITE | 52 DB 703 | |
| | PC1 | 01 WHITE | 02 D. CHOCO | 03 SILVER | 05 L. CHOCO |
| | | 12 ANTHRACITE | 14 RAL 9007 | 52 DB 703 | |
| | PC1 | 01 WHITE | 04 BEIGE | 06 ASH | 09 HAZELNUT |
| | | 10 GREY | 15 L. GREY | 08 GREEN | |

ALU slats are filled with insulation – polyurethane foam, standard fitted with anti-theft springs. Machine slat binding ensures a quieter and more reliable operation.

| | | | | | |
|-----|---------------|-------------|---------------|------------------|-------------|
| PC2 | 04 BEIGE | 08 GREEN | 10 L. GREY | 11 ANTIKO GRIGIO | 13 GRAPHITE |
| | 15 OCHRE | 18 RAL 8017 | | | |
| PC3 | 06 ASH | 07 WALNUT | 16 GOLDEN OAK | | |
| | 17 WALNUT GFA | 21 RAL 3011 | | | |

WARNING: Certain colours on the chart may vary from original!

CABINET, GUIDERAILS, END SLAT | Color palette:

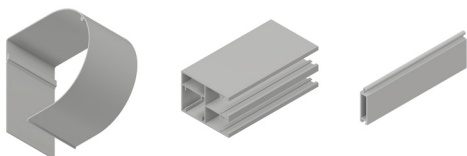

| | | | |
|-----|--------------|--------------|--------------|
| PC1 | 013 WHITE | 010 RAL 9006 | 090 RAL 9007 |
| | 042 RAL 7016 | 066 RAL 8019 | 052 DB 703 |
| PC2 | | | |

WARNING: Certain colours on the chart may vary from original!

MANIPULATION:



Manipulation is possible with automaton or electrical motor. For motor operation there is the standard PLUG & PLAY function, which allows the connection of several motors to a single switch, self-adjusting positions and the safety function in the event of an obstacle.



External roller shutter OVAL



TEHNICAL DRAWINGS | Shade details:

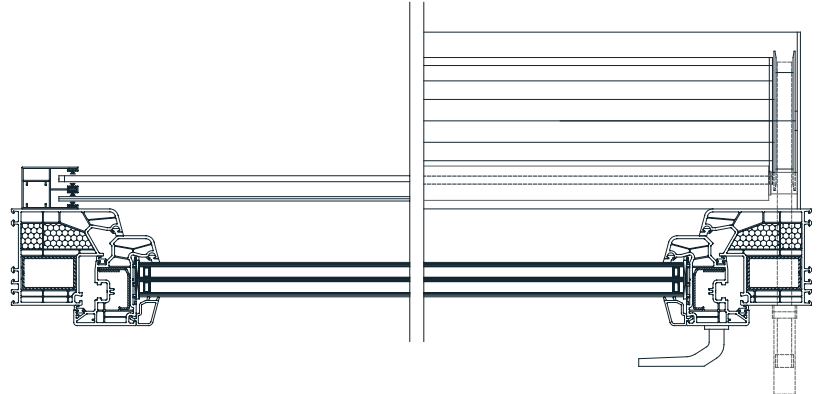
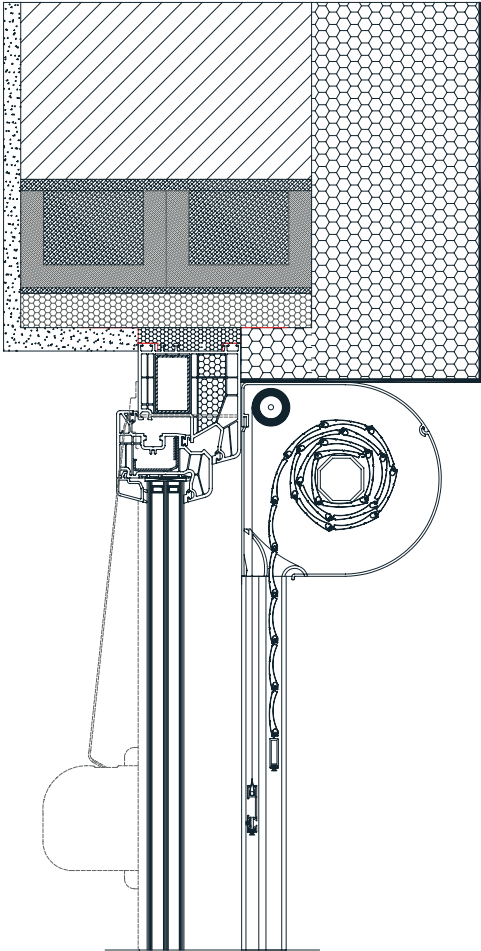

OVAL 150

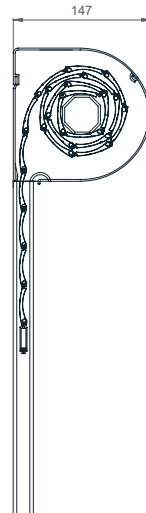

OVAL 165

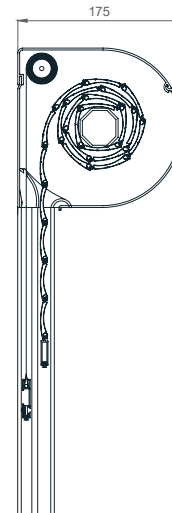

OVAL 180

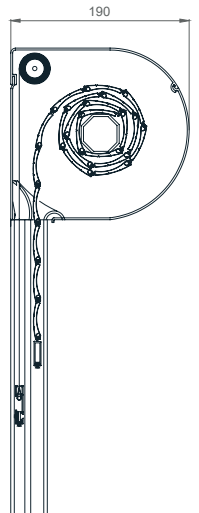

GUIDERAILS

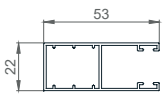

53 X 22mm

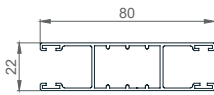

80 X 22mm

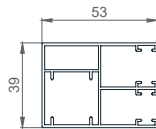

53 X 39mm

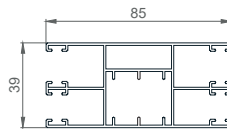

85 X 39mm

SLATS

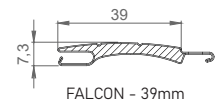

FALCON - 39mm

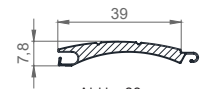

ALU - 39mm

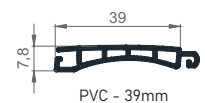

PVC - 39mm

TABLE OF BOX (CABINET) SIZES

| Slat/Shaft cabinet size | FALCON / 60mm | | ALU / 40mm | | ALU / 60mm | | PVC / 40mm | | PVC / 60mm | |
|-------------------------|---------------|-------|------------|-------|------------|-------|------------|-------|------------|-------|
| | | MOS. | | MOS. | | MOS. | | MOS. | | MOS. |
| 13,7 cm | 105,0 | - | 173,9 | - | 146,3 | - | 146,3 | - | 126,8 | - |
| 15,0 cm | 130,0 | 105,0 | 204,9 | 150,8 | 189,9 | 139,9 | 182,0 | 123,5 | 158,6 | 104,0 |
| 16,5 cm | 195,0 | 130,0 | 265,0 | 202,3 | 249,9 | 199,9 | 221,9 | 186,5 | 202,3 | 171,1 |
| 18,0 cm | 245,0 | 210,0 | 319,9 | 255* | 309,9 | 255* | 277,7 | 255* | 257,6 | 255* |
| 19,0 cm | 270,0 | 250,0 | - | - | - | - | - | - | - | - |
| 20,5 cm | - | - | 407,1 | * | 376,2 | * | 341,1 | * | 360,6 | * |