

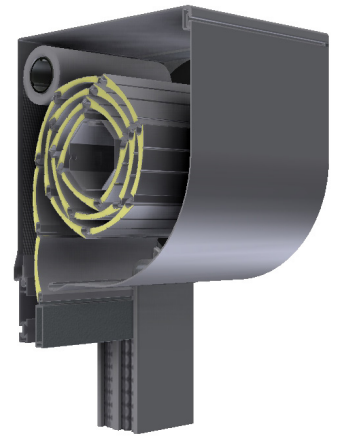

External roller shutter Quarter-OVAL

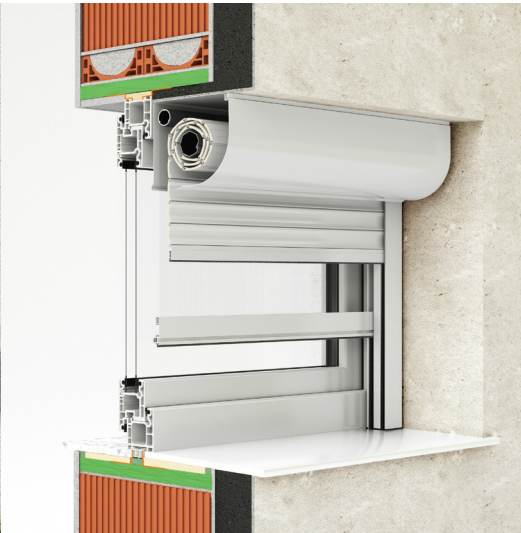

- HEAT PROTECTION
- ANTI-THEFT PROTECTION
- LIGHT REGULATION
- DIMMING
- UV PROTECTION
- HEATING / COOLING SAVINGS

If you want to embellish the external appearance of the building, we suggest mount-on external QUARTER-OVAL roller shutters. Roller box is composed of two parts (aluminium plate): the back part, which is the same in most of the shutters, and the front curved part, which also serves as a servicing panel.

SLATS | Color palette:

	PC1	01 WHITE	02 D. CHOCO	03 SILVER	04 BEIGE
		11 ANTIKO GRIGIO	12 ANTHRACITE	52 DB 703	
	PC1	01 WHITE	02 D. CHOCO	03 SILVER	05 L. CHOCO
		12 ANTHRACITE	14 RAL 9007	52 DB 703	
	PC1	01 WHITE	04 BEIGE	06 ASH	09 HAZELNUT
		10 GREY	15 L. GREY	08 GREEN	

ALU slats are filled with insulation – polyurethane foam, standard fitted with anti-theft springs. Machine slat binding ensures a quieter and more reliable operation.

PC2	04 BEIGE	08 GREEN	10 L. GREY	11 ANTIKO GRIGIO	13 GRAPHITE
	15 OCHRE	18 RAL 8017			
PC3	06 ASH	07 WALNUT	16 GOLDEN OAK		
	17 WALNUT GFA	21 RAL 3011			

WARNING: Certain colours on the chart may vary from original!

CABINET, GUIDERAILS, END SLAT | Color palette:

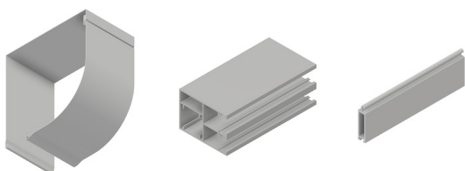

PC1	013 WHITE	010 RAL 9006	090 RAL 9007
	042 RAL 7016	066 RAL 8019	052 DB 703
PC2			

WARNING: Certain colours on the chart may vary from original!



MANIPULATION:



Manipulation is possible with automaton or electrical motor. For motor operation there is the standard PLUG & PLAY function, which allows the connection of several motors to a single switch, self-adjusting positions and the safety function in the event of an obstacle.

External roller shutter Quarter-OVAL



TEHNICAL DRAWINGS | Shade details:

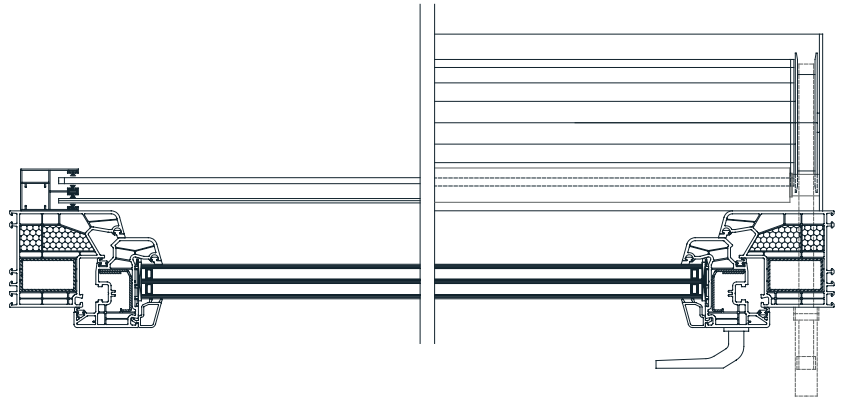
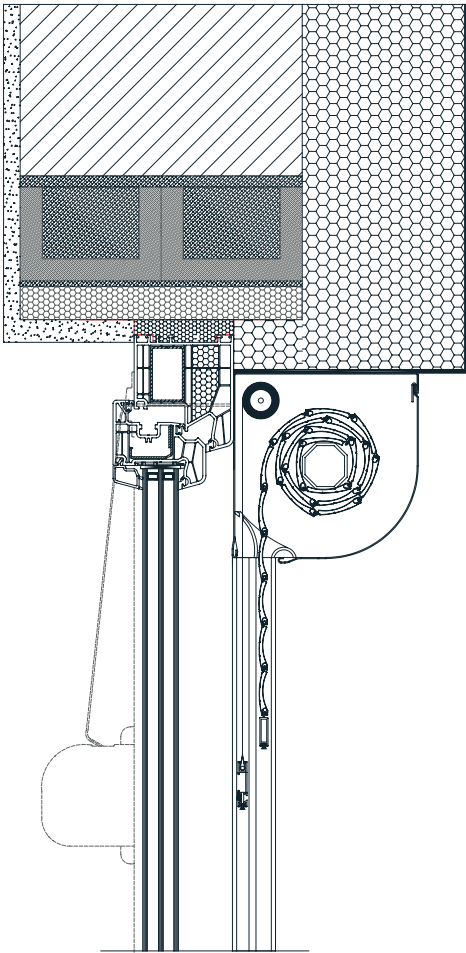

QUARTER-OVAL 150

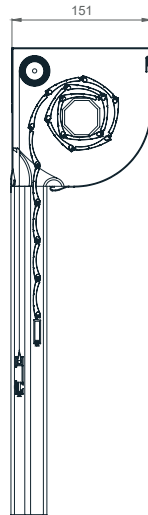

QUARTER-OVAL 180

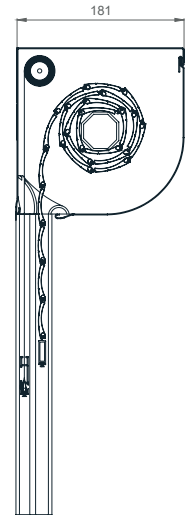

GUIDERAILS

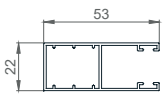

53 X 22mm

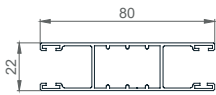

80 X 22mm

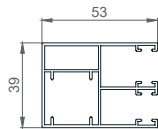

53 X 39mm

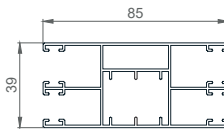

85 X 39mm

SLATS

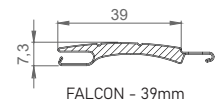

FALCON - 39mm

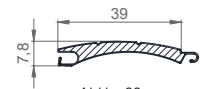

ALU - 39mm

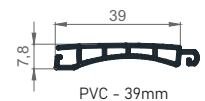

PVC - 39mm

TABLE OF BOX (CABINET) SIZES

Slat/Shaft cabinet size	FALCON / 60mm		ALU / 40mm		ALU / 60mm		PVC / 40mm		PVC / 60mm	
		MOS.		MOS.		MOS.		MOS.		MOS.
13,7 cm	105,0	-	173,9	-	146,3	-	146,3	-	126,8	-
15,0 cm	130,0	105,0	204,9	150,8	189,9	139,9	182,0	123,5	158,6	104,0
16,5 cm	195,0	130,0	265,0	202,3	249,9	199,9	221,9	186,5	202,3	171,1
18,0 cm	245,0	210,0	319,9	255*	309,9	255*	277,7	255*	257,6	255*
19,0 cm	270,0	250,0	-	-	-	-	-	-	-	-
20,5 cm	-	-	407,1	*	376,2	*	341,1	*	360,6	*