

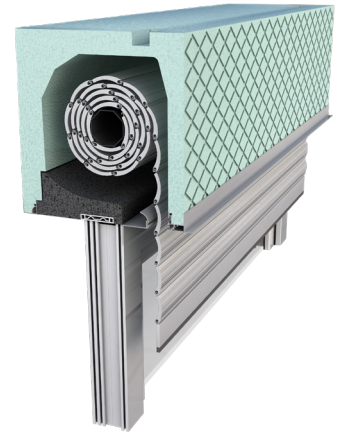

Built-in roller shutter TERMOBOX-R

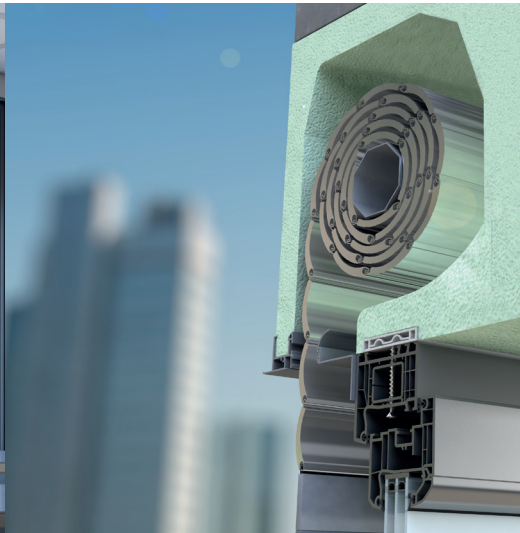

- **HEAT PROTECTION**
- **ANTI-THEFT PROTECTION**
- **LIGHT REGULATION**
- **DIMMING**
- **UV PROTECTION**
- **HEATING / COOLING SAVINGS**

The company Roletarstvo Medle presents a new insulation box TERMOBOX - R, which is suitable for roller shutters. Paper insulated housing is the ideal solution for installation in the new buildings (passive house), where maximum isolation, the exact box claims with the help of RAL assembly. The box is also suitable for the renovation where you want to replace the windows. The box is mounted directly above the window and then built all together into the opening. The box is completely hidden by the plaster, so it does not affect the external appearance of the building.

SLATS | Color palette:

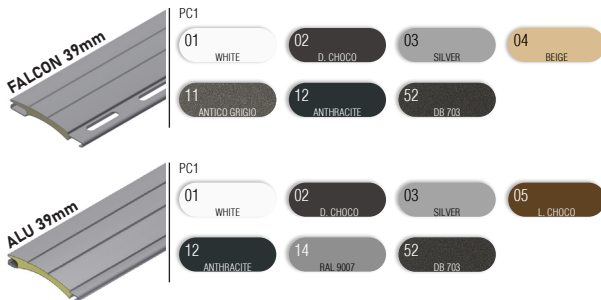

ALU slats are filled with insulation - polyurethane foam, standard fitted with anti-theft springs. Machine slat binding ensures a quieter and more reliable operation.

CABINET, GUIDERAILS, END SLAT | Color palette:

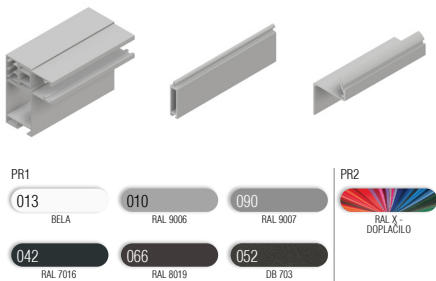

Zunanji L-profil ni v barvi!

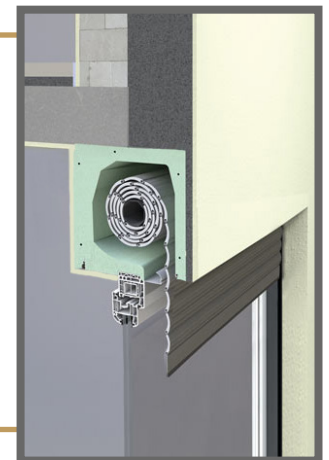

WARNING: Certain colours on the chart may vary from original!

MANIPULATION:



Manipulation is possible with automaton or electrical motor. For motor operation there is the standard PLUG & PLAY function, which allows the connection of several motors to a single switch, self-adjusting positions and the safety function in the event of an obstacle.

Built-in roller shutter TERMBOX - R



TEHNIICAL DRAWINGS | Shade details:

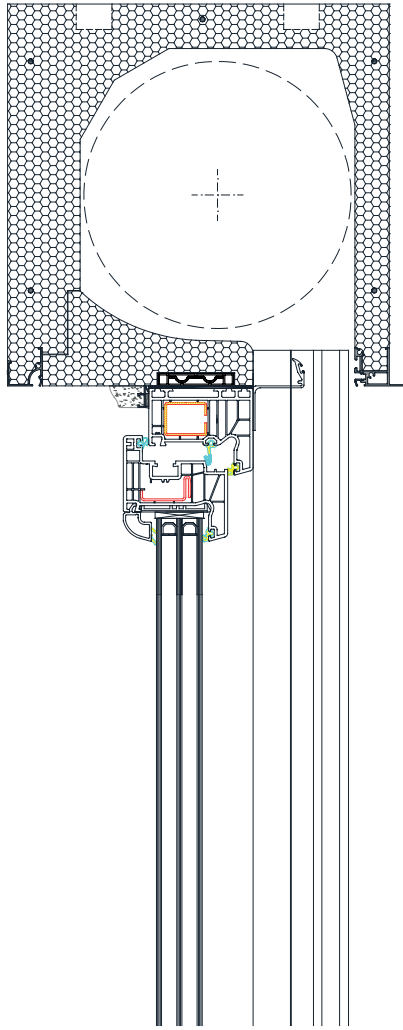

GUIDE DELAY

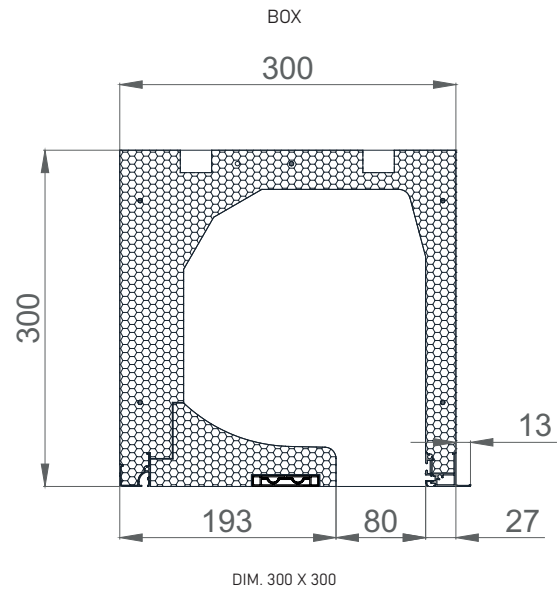
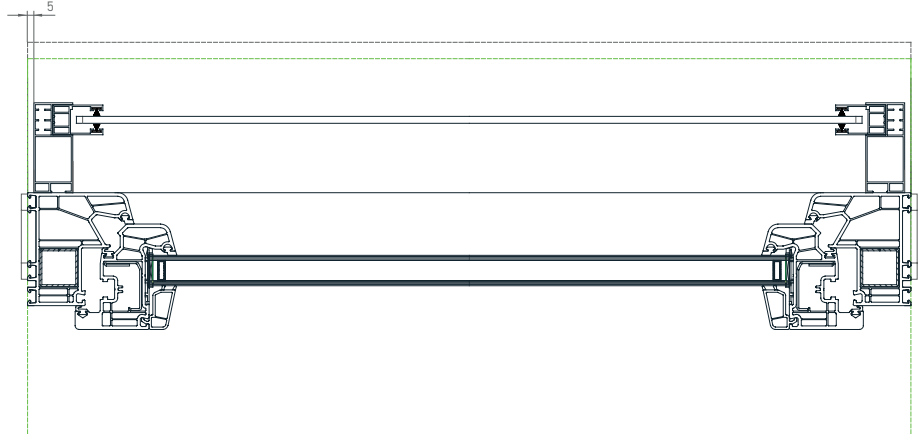

GUIDE

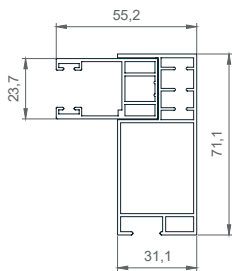

CLOSING PROFILE

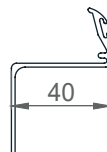

SLATS

